

GENERAL FEATURES

- **Long Service Life** - Thick plate design and efficient gas recombination yield a service life expectancy of up to 10 years in standby mode.
- **Low Internal Resistance** - Superb high-rate discharge characteristics ensure reliable performance in UPS and Telecom applications.
- **Maintenance-Free, Non-Spillable** - Proven VRLA technology guarantees safe operation without maintenance and 'non- restricted article' status for transportation.
- **Low Self-Discharge** - Lead-calcium alloy grids and use of high purity lead account for superior shelf-life characteristics permitting storage for extended periods of time.
- **Designed-In Reliability** - Cutting-edge manufacturing and process control combined with meticulous quality assurance procedures guarantee consistent and dependable performance



PERFORMANCE SPECIFICATIONS

Nominal Voltage	12V(6 cells)	
Design Floating Life @25°C	12 Years	
Nominal Capacity @25°C	20 hour rate 5.5A to 10.50V	110.00Ah
	10 hour rate 9.65A to 10.50V	96.50Ah
	5 hour rate 16.90A to 10.20V	84.50Ah
Internal Resistance	3 hour rate 25.30A to 9.90V	75.90Ah
	1 hour rate 61.50A to 9.60V	61.50Ah
	Full Charged Battery@25°C	<7.2mΩ
Energy Density (20-hr. rate)	101.63W-h/l	
Specific Energy (20-hr. rate)	40.00W-h/kg	
Shelf Life (nominal capacity at 20°C)	1 Month	97%
	3 Months	91%
	6 Months	83%
Max.Discharge Current@25°C	7 Min.	330.0A
Max Short-Duration Discharge Current	10 Sec	825.0A
Standby Use Charge (Constant Voltage) @25°C	Initial Charging Current Less than 33.0A	
	Voltage 13.6-13.8V	
Cycle Use Charge (Constant Voltage) @25°C	Initial Charging Current Less than 33.0A	
	Voltage 14.2-14.4 V	
Operating Temperature Range	Charge	-20°C to 50°C
	Discharge	-40°C to 60°C

GENERAL FEATURES mm

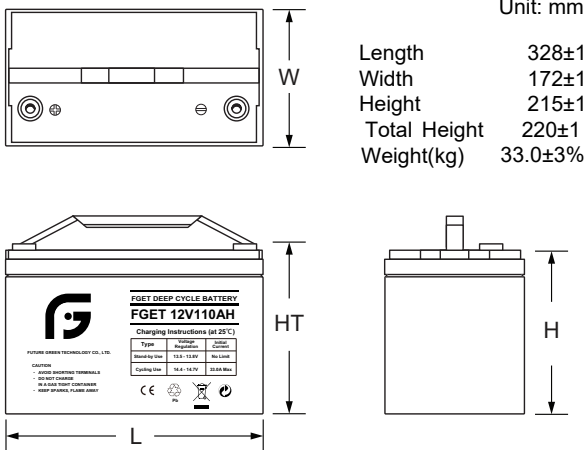

TERMINALS mm

- T11 - THREADED INSERT - 8mm STUD

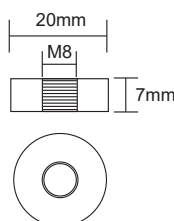

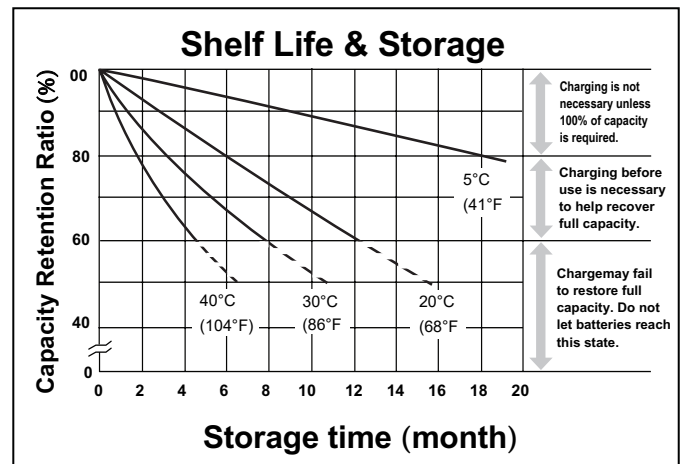
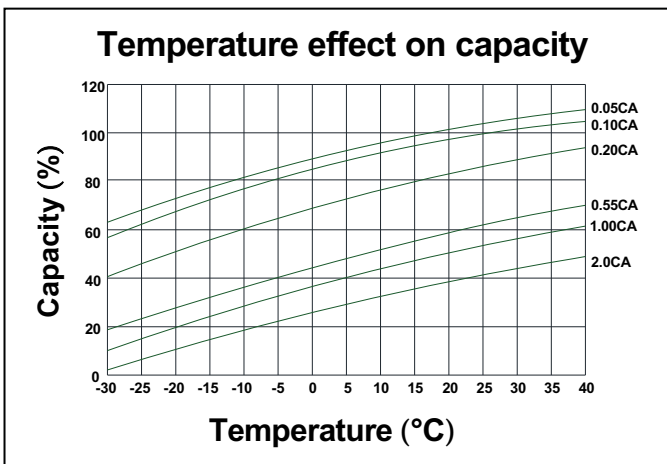
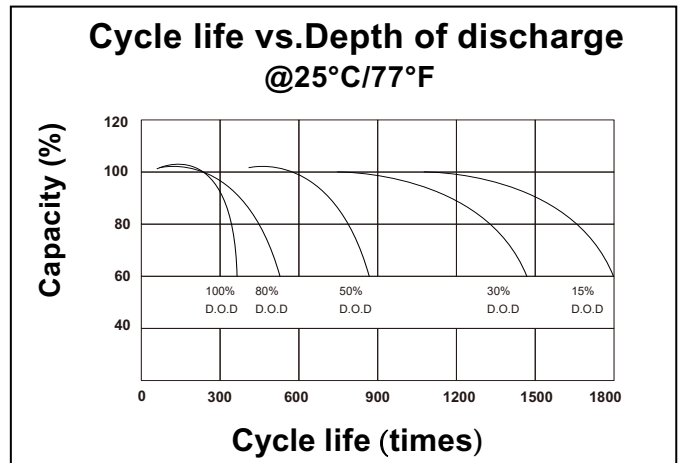
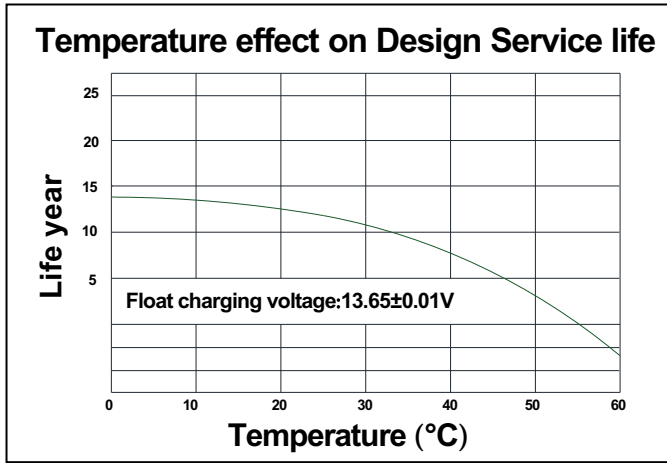
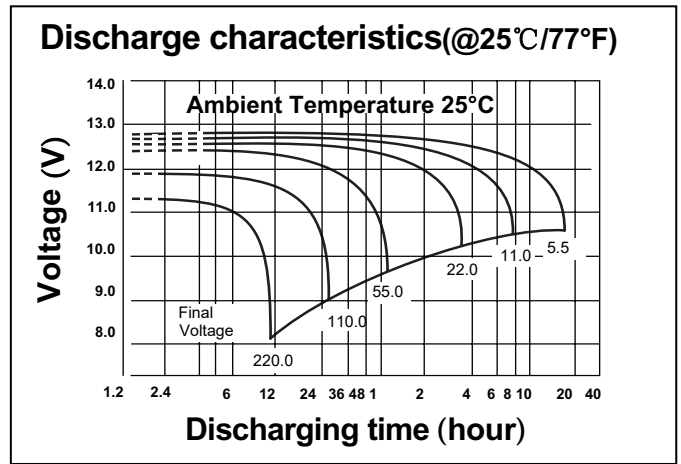
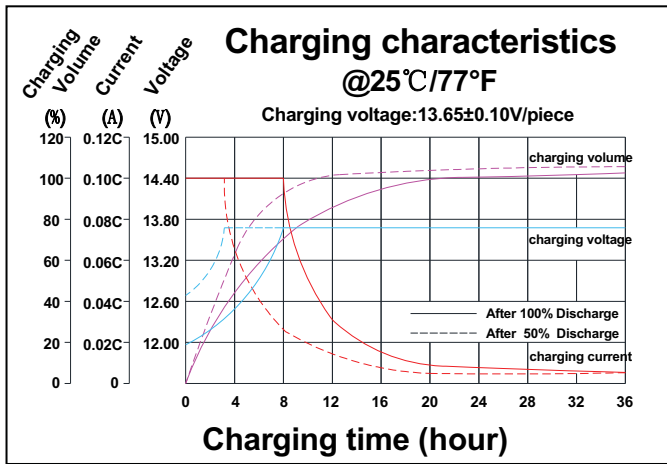

CONSTANT CURRENT DISCHARGE RATINGS (Amperes at 25°C)

F.V/Time	10MIN	15MIN	30MIN	1HR	2HR	3HR	4HR	5HR	8HR	10HR	20HR
9.60V	185.4	145.0	95.4	55.9	33.4	23.1	19.1	16.1	11.0	9.12	5.50
10.0V	176.4	142.1	93.8	55.6	33.2	23.0	19.0	16.0	10.9	9.03	5.30
10.2V	170.1	139.8	93.0	55.1	32.9	22.8	18.9	15.9	10.8	8.95	5.15
10.5V	158.9	134.7	93.2	54.6	32.7	22.7	18.8	15.7	10.7	8.86	5.00
10.8V	146.6	125.6	92.5	53.3	32.1	22.1	18.3	15.4	10.6	8.77	4.70
11.1V	132.5	114.0	87.4	50.7	30.7	21.1	17.4	14.8	10.1	8.51	4.50